

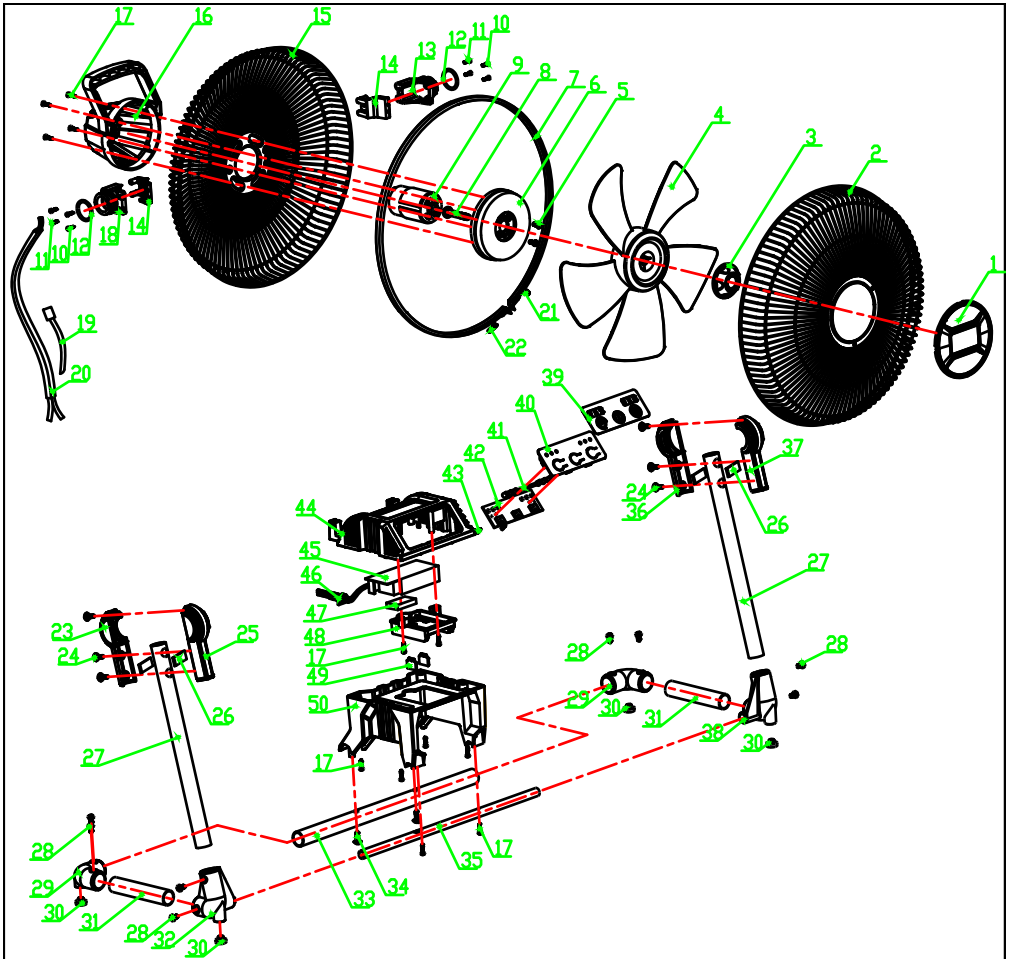











EXPLODED VIEW



SPARE PARTS LIST

NO.	name	picture	data	pcs
1	Fan Face Cover		ABS	1
2	Net cover B			1
3	Fan twist		PA6-30GF	1
4	Fan		φ 149	1
5	Crosshead pan head screw		M4×12	2
6	Motor front cover		PA6-30GF	1
7	Clamp			1
8	Motor shaft connections		PA6-30GF	1
9	9V motor			1
10	Cross-recessed pan head tapping screw		ST3×10	4
11	Cross-recessed pan head tapping screw		ST3×20	6
12	O-ring		内径φ 25×3	2
13	Right Fixing Block Cover		ABS	1
14	Fixing block base		ABS	2
15	Net cover A			1
16	Rear cover of motor		ABS	1
17	Cross-recessed pan head tapping screw		ST3×16	4
18	Cover for left retaining block		ABS	1
19	Tie-wrap			1
20	Power supply connection wire		H03VV-2*0.5*	1
21	Nut		M4	1
22	Crosshead pan head screw		M4×16	1
23	Under left support joint		ABS	1
24	Cross-recessed pan head tapping screw		ST4×16	6
25	Left support joint		ABS	1
26	Foaming pad		25*10*2.5	8
27	Left and right circular pipe of phi 22 x 1.3			2
28	Screw		ST4*16	8
29	90 Degree Bend		ABS	2
30	Fan footrest		TPR	4
31	Bottom connecting pipe of 22 x 1.3			2
32	Left elbow - 77 degrees			
33	Pipe with base of 22 x 1.3			1
34	Cross-recessed pan head tapping screw (large head)		ST4×18	2

SPARE PARTS LIST

35	Pipe with base of 12 x 1.3			1
36	Under right support joint		ABS	1
37	Right support joint		ABS	1
38	Right elbow - 77 degrees		PA6-30GF	1
39	Switch film application			1
40	Switch panel		ABS	1
41	Light guide pillar		PC	1
42	Circuit Board			1
43	Cross-recessed pan head tapping screw		ST2.5x10	2
44	Upper cover of battery pack holder		ABS	1
45	Power Supply Board			1
46	Power cord plug		H03VV-2*0.5	1
47	Foaming pad		25*15*4	1
48	Battery bag socket		PA6-30GF	1
49	Illustration			2
50	Lower cover of battery pack holder		ABS	1